





VOLTHOCKEY

Accessories and spare parts, 2019.

All accessories and spare parts are listed with a product picture, item number and product name. In most cases a position number is shown below the item number. On page 15-16 you will find an illustration of the VoltHockey chair with the corresponding position numbers.







VOLTHOCKEY

Product picture	Item number	Product name
	101240	VoltHockey Medio
	101241	VoltHockey Maxi
	101242	VoltHockey Maxi+

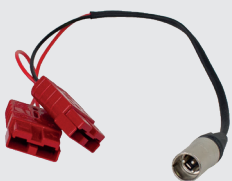
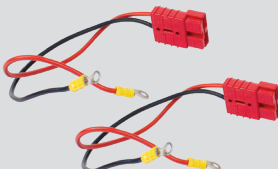
IMMO A/S
Friis Hansens Vej 9 - DK-7100 Vejle
+45 7585 8022
hello@immodenmark.dk
immodenmark.dk

IMMO  **KEEP
MOVING**

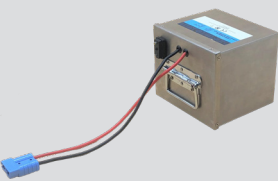
ACCESSORIES AND SPARE PARTS

Product picture	Item number	Product name
	101364	Adapter
	101365 (Position: 42)	Battery wiring kit incl. plug, set
	101366 (Position: 43)	Battery set incl. plug, 20Ah Vision
	101367 (Position: 43)	Battery 20Ah, incl. handle
	101368 (Position: 48)	Charger 24V, 2,5A, incl. plug (Used for 20Ah batteries)
	100378 (Position: 43)	Battery 40Ah, li-ion, incl. plug
	100630 (Position: 48)	Charger 24V, 15-25A, incl. plug (Used for 40Ah li-ion batteries)

IMMO A/S
 Friis Hansens Vej 9 - DK-7100 Vejle
 +45 7585 8022
 hello@immodenmark.dk
 immodenmark.dk

IMMO  **KEEP MOVING**



ACCESSORIES AND SPARE PARTS

Product picture	Item number	Product name
	100355 (Position: 33L or 33R)	Complet motor and gear, left or right
	101276 (Position: 46)	Power module, VR2, 60 A
	101370 (Position: 11a + 11b + 11c + 11d)	Paddle complete, assembled
	100708 (Position 18L or 18R)	Acrylic cover at footplat, left or right side
	101249 Right 101250 Left (Position 5 or 15)	Hand guard, left or right
	100807 (Position: 34)	Long-grooved tire, 300 x 4"
	100833	Wheel inner tube to driving wheel, 300 x 4"

IMMO A/S
 Friis Hansens Vej 9 - DK-7100 Vejle
 +45 7585 8022
 hello@immodenmark.dk
 immodenmark.dk

IMMO  **KEEP MOVING**

ACCESSORIES AND SPARE PARTS

Product picture	Item number	Product name
	101279	Cable for computer programming incl. adapter
	100999 (Position: 17)	Joystick
	100824 (Position: 32)	Steering wheel, rear, complete air rubber wheel with rims, 200x50
	100840 (Position: 9)	Locking pin, long

IMMO A/S
 Friis Hansens Vej 9 - DK-7100 Vejle
 +45 7585 8022
 hello@immodenmark.dk
 immodenmark.dk

IMMO  **KEEP MOVING**

POSITION OVERVIEW

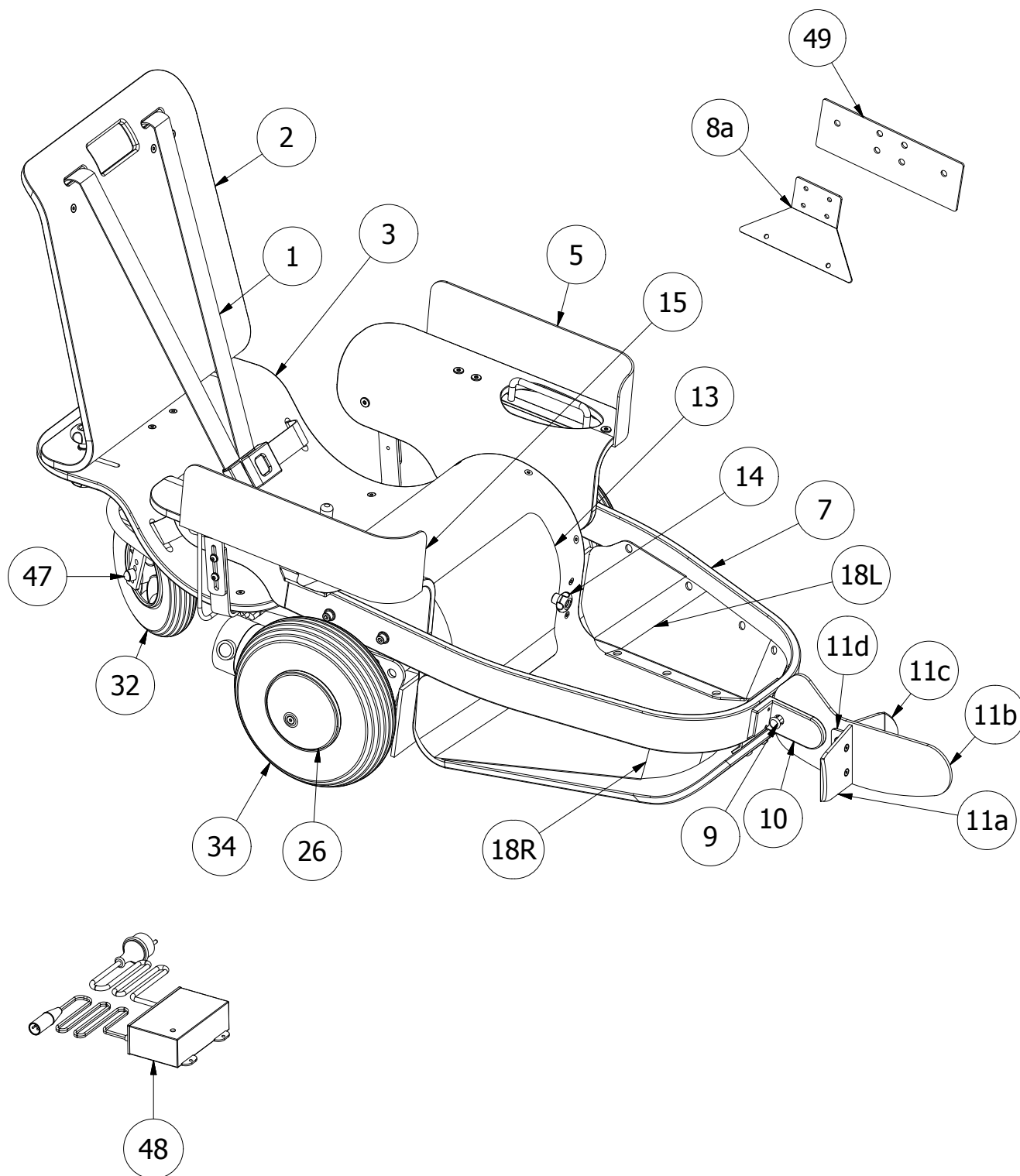

IMMO A/S
Friis Hansens Vej 9 - DK-7100 Vejle
+45 7585 8022
hello@immodenmark.dk
immodenmark.dk

IMMO  **KEEP MOVING**

POSITION OVERVIEW

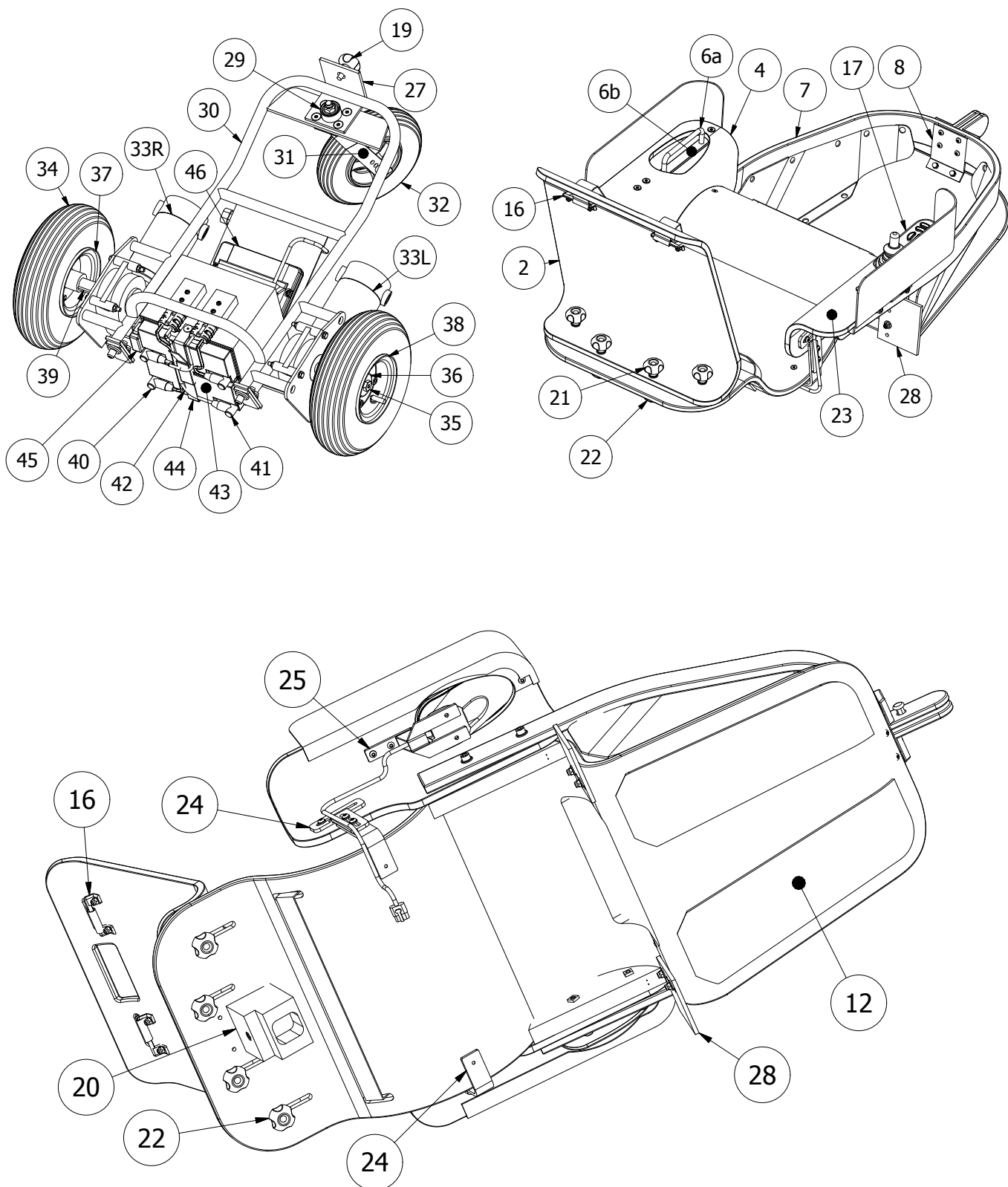

IMMO A/S
 Friis Hansens Vej 9 - DK-7100 Vejle
 +45 7585 8022
 hello@immodenmark.dk
 immodenmark.dk

IMMO  **KEEP MOVING**